

# My BOX MADELUX

DA 400x400cm a 600x600cm  
MISURE PERSONALIZZABILI

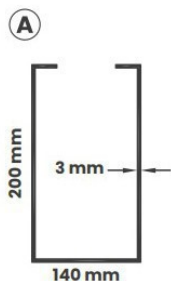

**Trave perimetrale lato alto**

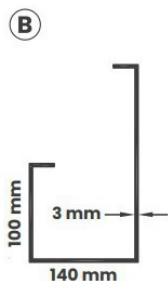

**Trave perimetrale lato basso**

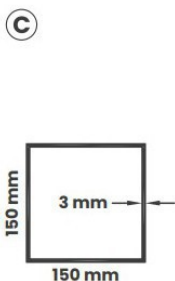

**Piantone**

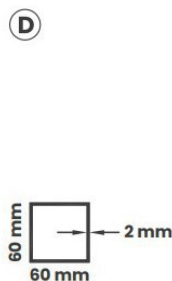

**Profilo rompitratta**

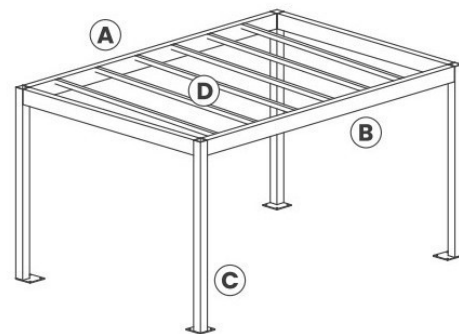

## SPECIFICHE STAFFE A PARETE E SOFFITTO

STAFFA A PARETE

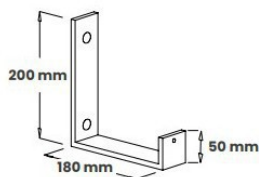

STAFFA A PARETE CON TRAVE

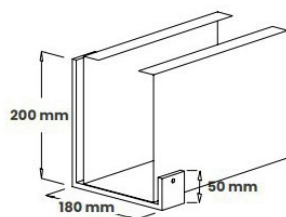

STAFFA A SOFFITTO

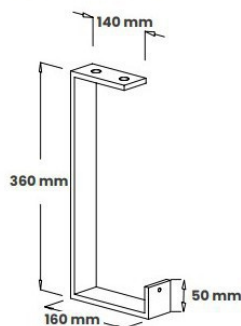

STAFFA A SOFFITTO CON TRAVE

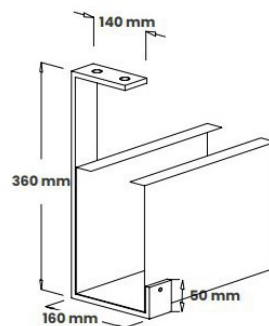

Per strutture con attacco a parete o a soffitto stesso costo della struttura autoportante.

## SOLUZIONI PER POSIZIONE PIASTRA PIANTONE

Da specificare in fase d'ordine, in caso di omissione la struttura sarà fornita con soluzione TIPO A

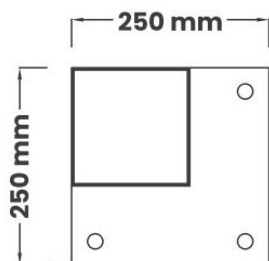

**PIASTRA DI BASE TIPO A:**  
piantone posizionato all'angolo della piastra.

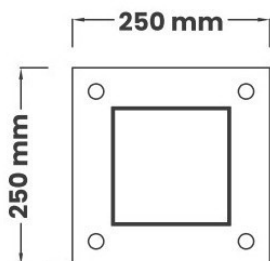

**PIASTRA DI BASE TIPO B:**  
piantone posizionato al centro della piastra.



**PIASTRA DI BASE TIPO C:**  
piantone ad innesto con piastra a scomparsa.  
**+ € 50,00 per 1 piantone.**

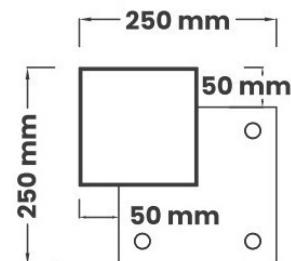

**PIASTRA DI BASE TIPO D:**  
predisposizione per montaggio Clear