

# My BOX MADELUX

200x300cm - 200x400cm -  
300x300cm - 300x400cm -  
MISURE PERSONALIZZABILI

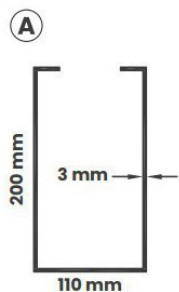

**A**  
Trave  
perimetrale  
lato alto

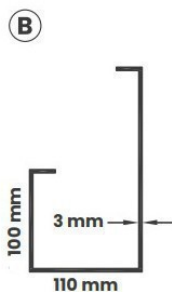

**B**  
Trave  
perimetrale  
lato basso

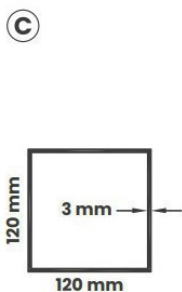

**C**  
Piantone

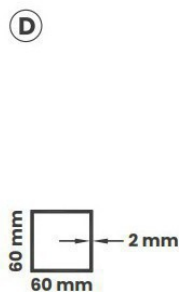

**D**  
Profilo  
rompitratte

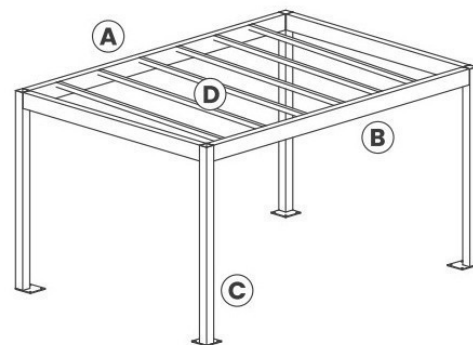

## SPECIFICHE STAFFE A PARETE E SOFFITTO

STAFFA A PARETE

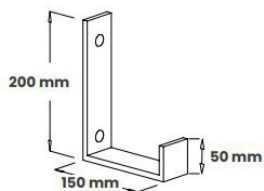

STAFFA A PARETE CON TRAVE

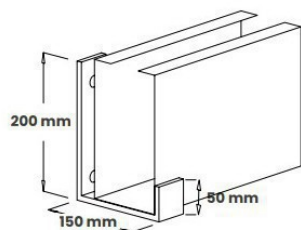

STAFFA A SOFFITTO

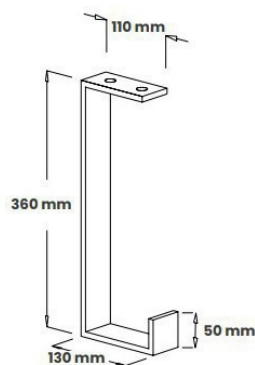

STAFFA A SOFFITTO CON TRAVE

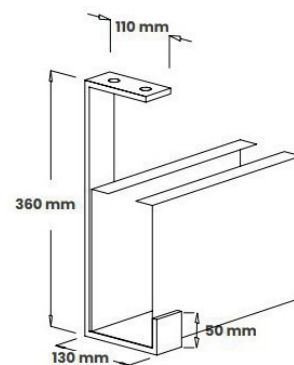

**Per strutture con attacco a parete o a soffitto stesso costo della struttura autoportante.**

## SOLUZIONI PER POSIZIONE PIASTRA PIANTONE

Da specificare in fase d'ordine, in caso di omissione la struttura sarà fornita con soluzione TIPO A

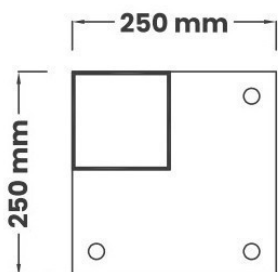

**PIASTRA DI BASE TIPO A:**  
piantone posizionato  
all'angolo della piastra.

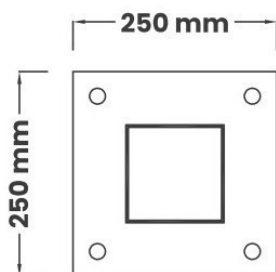

**PIASTRA DI BASE TIPO B:**  
piantone posizionato  
al centro della piastra.



**PIASTRA DI BASE TIPO C:**  
piantone ad innesto  
con piastra a scomparsa.  
**+ € 50,00 per 1 piantone.**

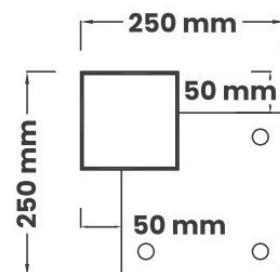

**PIASTRA DI BASE TIPO D:**  
predisposizione per  
montaggio Clear