

My BOX MADELUX

200x300cm - 200x400cm -
300x300cm - 300x400cm -
MISURE PERSONALIZZABILI

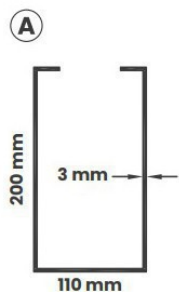

Trave perimetrale lato alto

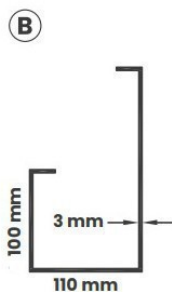

Trave perimetrale lato basso

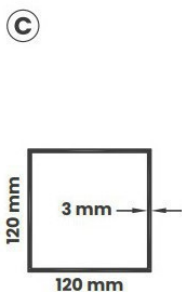

Piantone

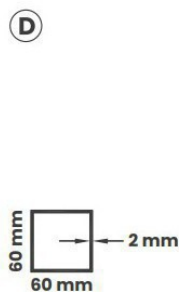

Profilo rompitratta

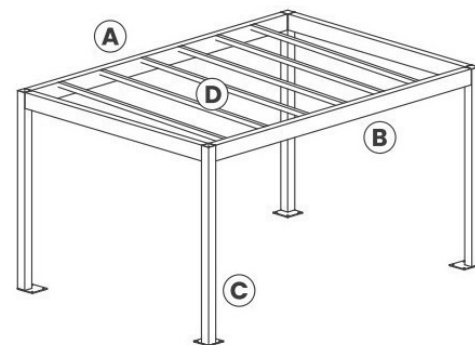

SPECIFICHE STAFFE A PARETE E SOFFITTO

STAFFA A PARETE

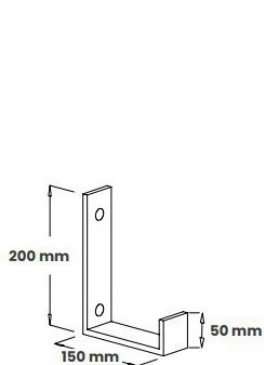

STAFFA A PARETE CON TRAVE

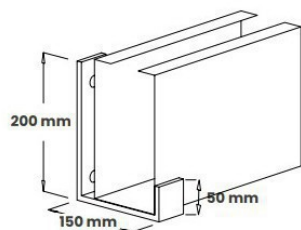

STAFFA A SOFFITTO

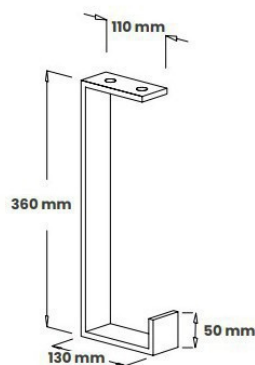

STAFFA A SOFFITTO CON TRAVE

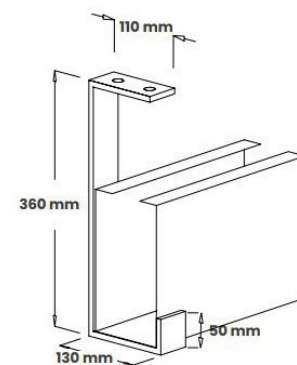

Per strutture con attacco a parete o a soffitto stesso costo della struttura autoportante.

SOLUZIONI PER POSIZIONE PIASTRA PIANTONE

Da specificare in fase d'ordine, in caso di omissione la struttura sarà fornita con soluzione TIPO A

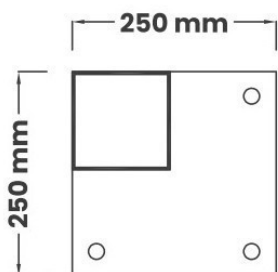

PIASTRA DI BASE TIPO A:
piantone posizionato all'angolo della piastra.

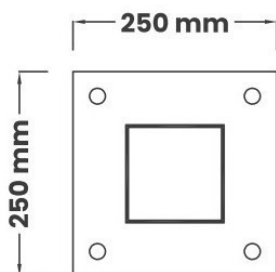

PIASTRA DI BASE TIPO B:
piantone posizionato al centro della piastra.



PIASTRA DI BASE TIPO C:
piantone ad innesto con piastra a scomparsa.
+ € 50,00 per 1 piantone.

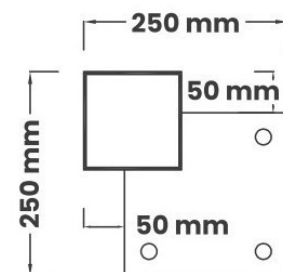

PIASTRA DI BASE TIPO D:
predisposizione per montaggio Clear