

MY BOX

GAZEBI PROFESSIONALI

DA 400x400cm a 600x600cm
MISURE PERSONALIZZABILI



TABELLA ALTEZZE			
MISURE (CM)	H1 (CM)	H2 (CM)	H3 (CM)
TUTTE	250	20	270

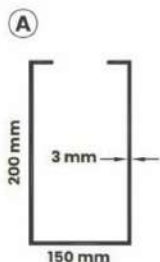

Trave perimetrale lato alto

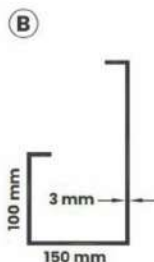

Trave perimetrale lato basso

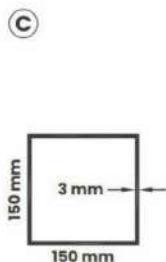

Piantone

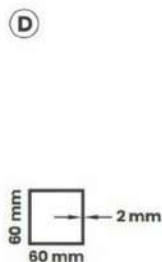

Profilo rompitratta

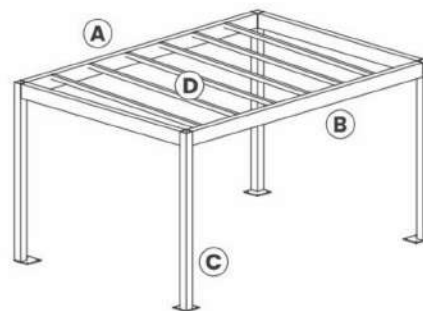

SPECIFICHE STAFFE A PARETE E SOFFITTO

STAFFA A PARETE CON TRAVE

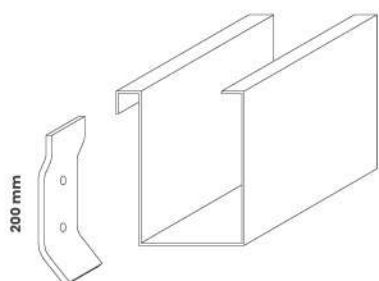

STAFFA A SOFFITTO

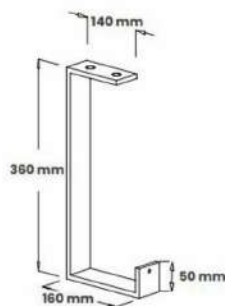

STAFFA A SOFFITTO CON TRAVE

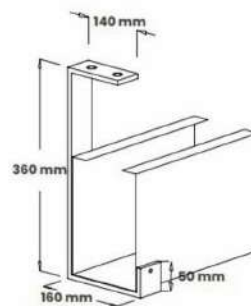

Per strutture con attacco a parete o a soffitto stesso costo della struttura autoportante.

SOLUZIONI PER POSIZIONE PIASTRA PIANTONE

Da specificare in fase d'ordine, in caso di omissione la struttura sarà fornita con soluzione TIPO A

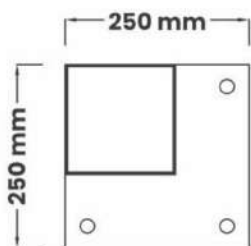

PIASTRA DI BASE TIPO A:
piantone posizionato all'angolo della piastra.

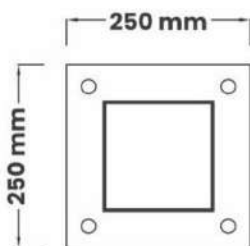

PIASTRA DI BASE TIPO B:
piantone posizionato al centro della piastra.



PIASTRA DI BASE TIPO C:
piantone ad innesto con piastra a scomparsa.
+ € 50,00 per 1 piantone.

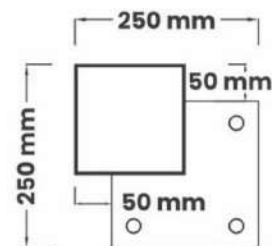

PIASTRA DI BASE TIPO D:
predisposizione per montaggio Clear