

# MY BOX

**GAZEBI  
PROFESSIONALI**

**200x300cm - 200x400cm -  
300x300cm - 300x400cm -  
MISURE PERSONALIZZABILI**



**TABELLA ALTEZZE**

MISURE (CM)	H1 (CM)	H2 (CM)	H3 (CM)
TUTTE	250	20	270

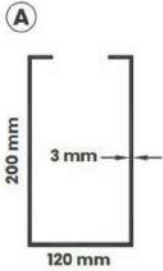

**Trave  
perimetrale  
lato alto**

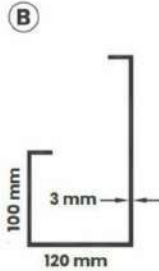

**Trave  
perimetrale  
lato basso**

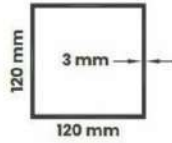

**Piantone**

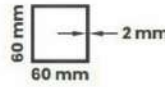

**Profilo  
rompitratta**

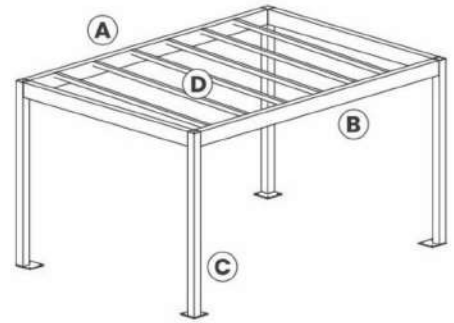

## SPECIFICHE STAFFE A PARETE E SOFFITTO

STAFFA A PARETE CON TRAVE

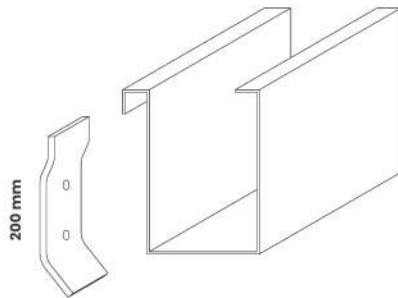

STAFFA A SOFFITTO

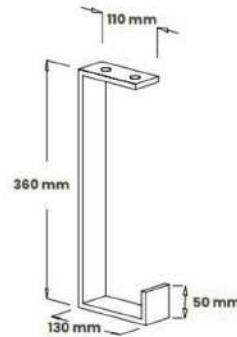

STAFFA A SOFFITTO CON TRAVE

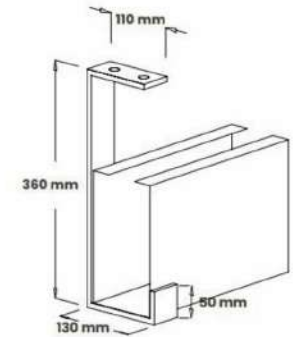

**Per strutture con attacco a parete o a soffitto stesso costo della struttura autoportante.**

## SOLUZIONI PER POSIZIONE PIASTRA PIANTONE

Da specificare in fase d'ordine, in caso di omissione la struttura sarà fornita con soluzione TIPO A

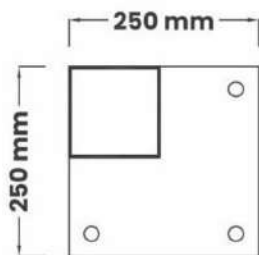

**PIASTRA DI BASE TIPO A:**  
piantone posizionato  
all'angolo della piastra.

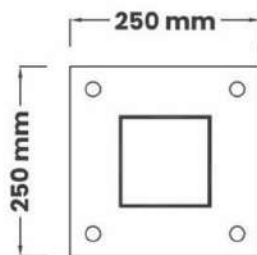

**PIASTRA DI BASE TIPO B:**  
piantone posizionato  
al centro della piastra.



**PIASTRA DI BASE TIPO C:**  
piantone ad innesto  
con piastra a scomparsa.  
**+ € 50,00 per 1 piantone.**

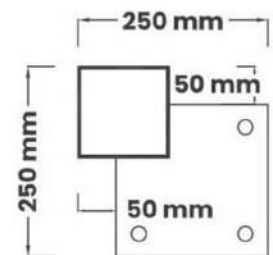

**PIASTRA DI BASE TIPO D:**  
predisposizione per  
montaggio Clear